

# GEMINI *an ultra-stable interferometer*

---

GEMINI is a novel and compact interferometer that can guarantee very high robustness and stability between the two generated replicas of light.

The exceptional performances of this device can be exploited in many different applications, such as time- and frequency-resolved fluorescence, coherent Raman, pump-probe, two-dimensional spectroscopy and studies on single molecules.

## Key Features

- High throughput that allows high sensitivities
- $\approx 1$  attosecond stability between the two replicas of light
- Fast scans ( $< 1$  sec.)
- Scan range selectable by the user
- Compact and low-cost
- Insensitive to vibrations

## Applications

- Interferometry
- Generation of pulse pairs

### GEMINI IN DETECTION PATH

- Time- and frequency- resolved fluorescence
- Pump-probe spectroscopy
- Coherent Raman spectroscopy

### GEMINI IN EXCITATION PATH

- Fluorescence Excitation-Emission Maps
- Characterization of single molecules



# Time- and frequency-resolved fluorescence with a single TCSPC detector

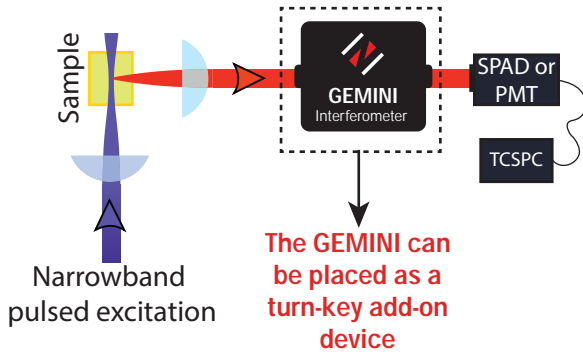

Experimental setup: GEMINI interferometer is placed in collection before the detector (a SPAD or PMT) connected to a TCSPC. This allows one to resolve the fluorescence wavelength axis while preserving the temporal resolution.

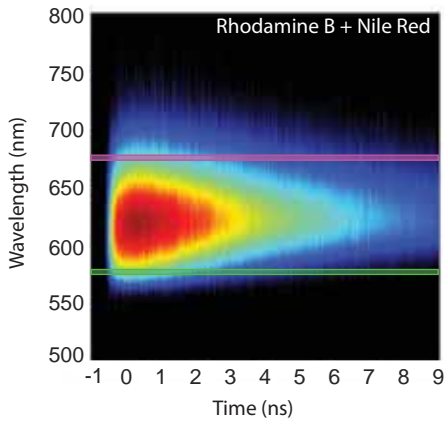

Fluorescence maps as a function of detection wavelength and emission time for a mixture of Rhodamine B and Nile Red in acetone solution.

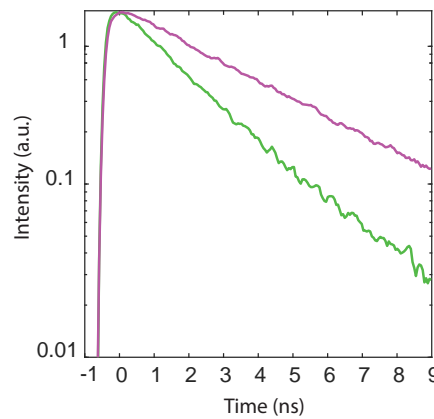

Semi-log plots of fluorescence decay traces at  $\approx 575$  nm (green curve) and  $\approx 675$  nm (purple curve).

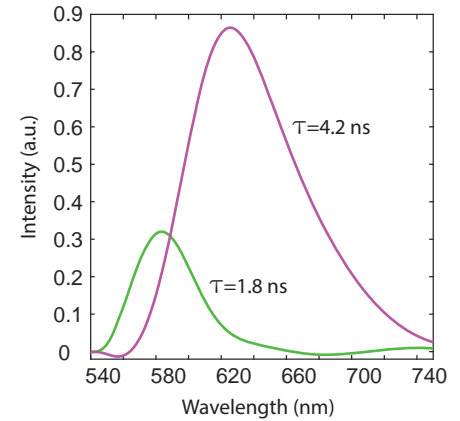

Integrated spectra of the two fluorophores computed from the correspondent Decay Associated Spectra (DAS) and lifetimes.

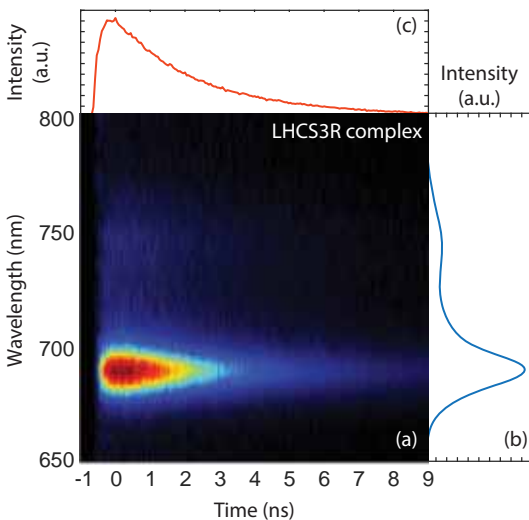

(a) Fluorescence map of the LHCSR3 complex from *C. reinhardtii*; (b-c) Marginals of (a), obtained by integrating the map along the horizontal and vertical directions, respectively, showing the overall fluorescence spectrum and decay dynamics.

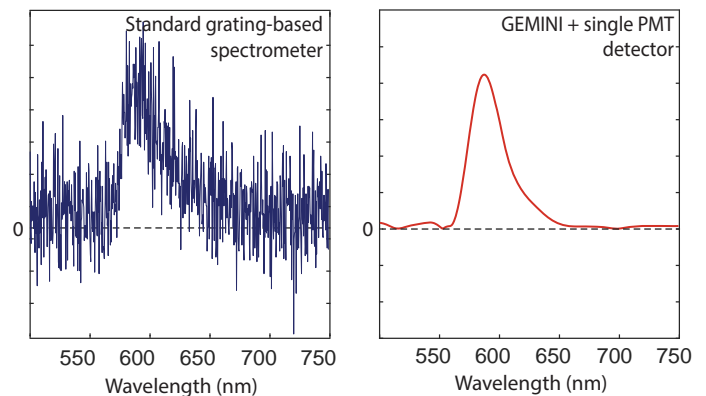

Comparison of fluorescence emission spectra of Rhodamine B, measured in the same experimental conditions. Excitation laser:  $\lambda=530$  nm,  $P=1$   $\mu$ W.

# Coherent Raman (Stimulated Raman Scattering - SRS) and Pump-Probe Spectroscopy

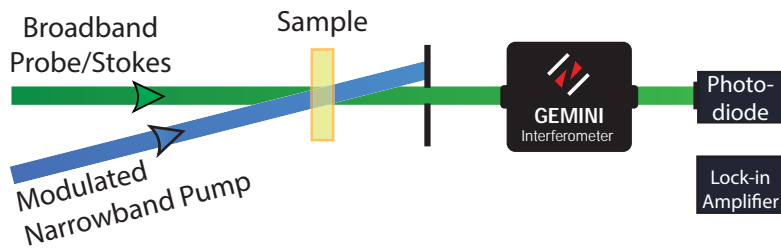

Experimental setup: GEMINI interferometer is placed in the probe/Stokes beam after the sample, allowing one to measure SRS or pump-probe spectra up to MHz modulation frequencies.

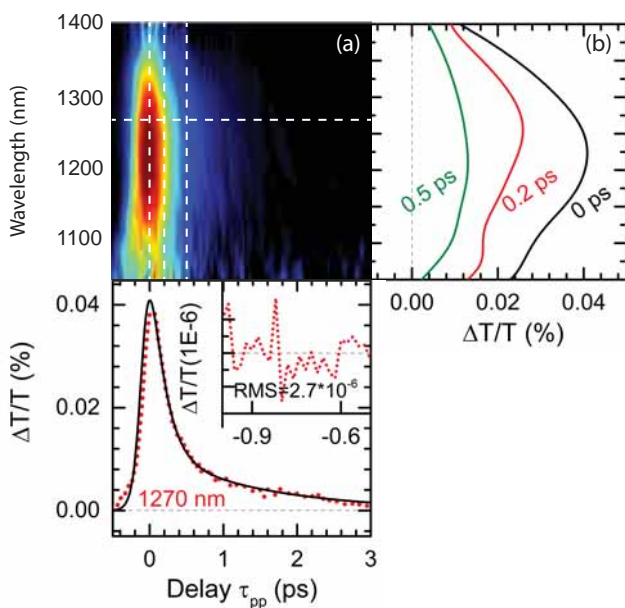

(a) Two-dimensional  $\Delta T/T(\lambda, \tau)$  map for a graphite sample prepared by liquid phase exfoliation. (b)  $\Delta T/T$  spectra at selected probe delays; (c)  $\Delta T/T$  dynamics at 1270-nm probe wavelength (red circles) together with a bi-exponential fit (black solid line). Inset: zoom of the signal for negative delays.

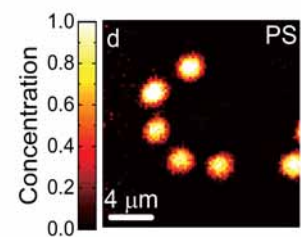
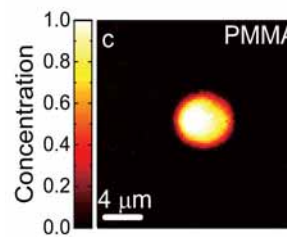
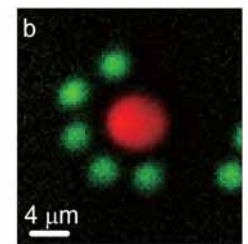
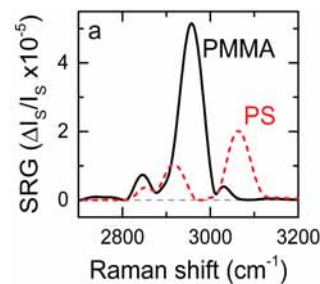

Chemometric analysis of the acquired dataset. (a) SRS spectra for PMMA (solid black line) and PS (dotted red line). (b) False-color image of the sample, showing a central bead of PMMA (in red), surrounded by smaller beads of PS (in green). (c) and (d): concentrations maps of PMMA and PS.

*F. Preda et al., Opt. Lett. 41, 2970-2973 (2016).*  
*J. Réhault et al., Opt. Express 23, 25235-25246 (2015).*

## Comparison with Monochromators

The GEMINI is designed to be added to your setup to extract the spectrum of any light source, coherent or not. It can replace monochromators, since it overcomes their main drawbacks in terms of low throughput, fixed spectral resolution and limited spectral coverage

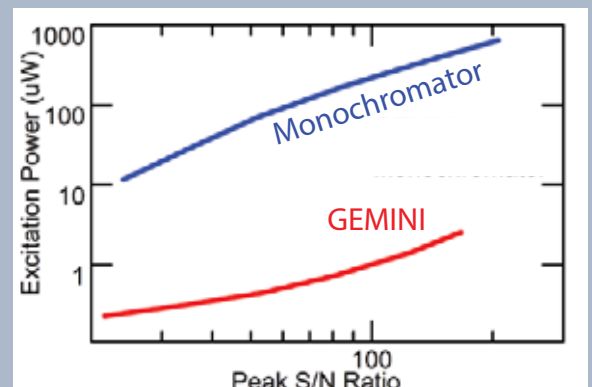
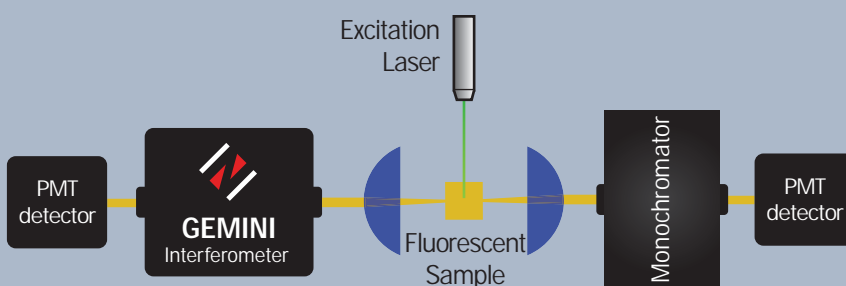

COMPARISON between GEMINI and a monochromator. The fluorescence of a sample is collected at 90° and measured with PMT detectors. The GEMINI and the monochromator enable to spectrally resolve the fluorescence. With the GEMINI, one can obtain the same S/N obtained with a monochromator with ~100 times lower excitation light power.

# Excitation-Emission Maps (EEMs) of Single Molecules

The GEMINI can be placed as a turn-key add-on device

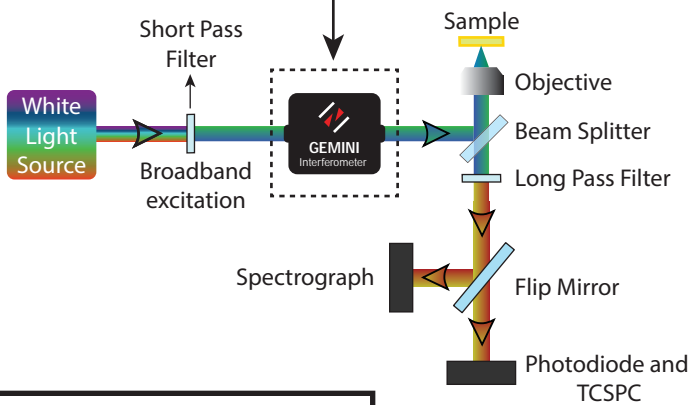

GEMINI interferometer allows the characterization of single molecules with **low acquisition times and exceptional accuracy and sensitivity**

Single molecule: *Terrylene diimide derivative*

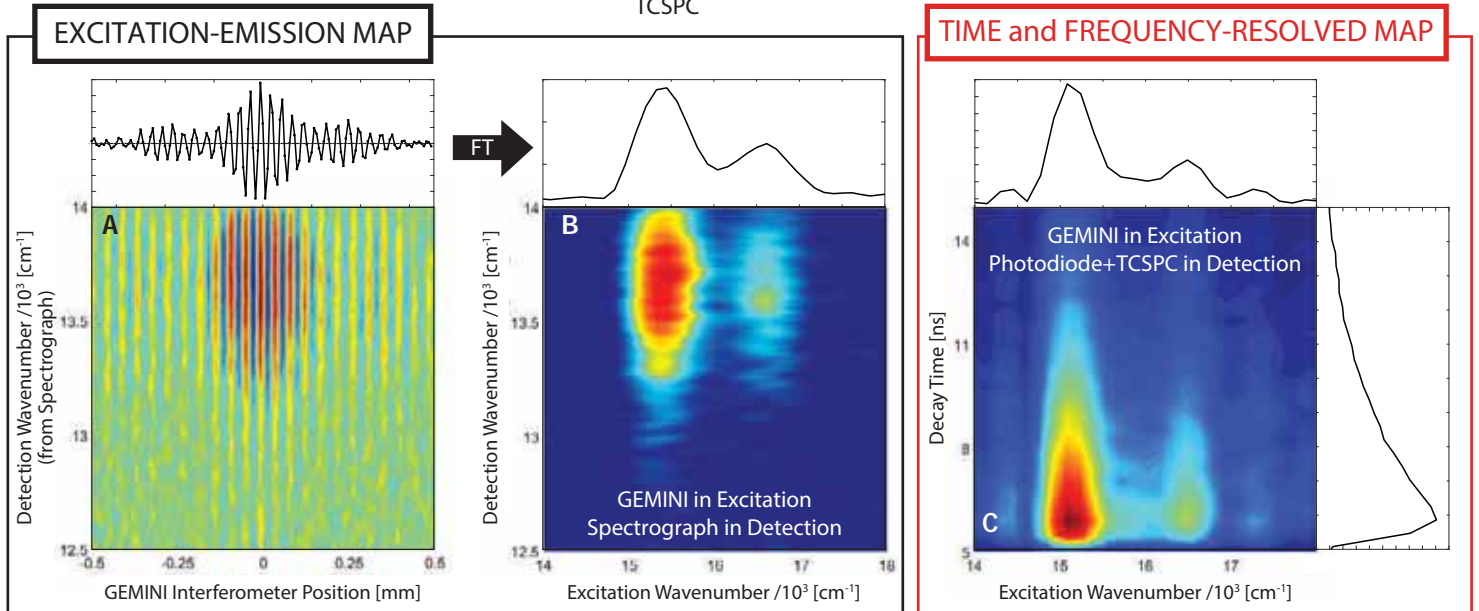

Thyrhaug et al., "Single-molecule excitation-emission spectroscopy", PNAS 201808290 (2019).

Single Molecule interferogram (A) and relative Excitation-Emission Map (B) obtained via Fourier Transform (FT) along the x-axis. (C) Excitation-energy versus emission-intensity decay for a single molecule constructed from an interferometric TCSPC experiment.

## Technical Specifications

VERSION	S	L
Spectral range [nm]	250 - 2300 (Standard) 250 - 3500 (Ultra-broadband) 500 - 4200 (On request)	
Max. Delay $\tau$ [fs @ $\lambda=600$ nm]	-100 $\rightarrow$ 700	-100 $\rightarrow$ 2000
Delay $\tau$ Stability	< 1 attosecond	
Dimensions [mm]	100 x 110 x 65	
Weight [kg]	1	

### Spectral Resolution

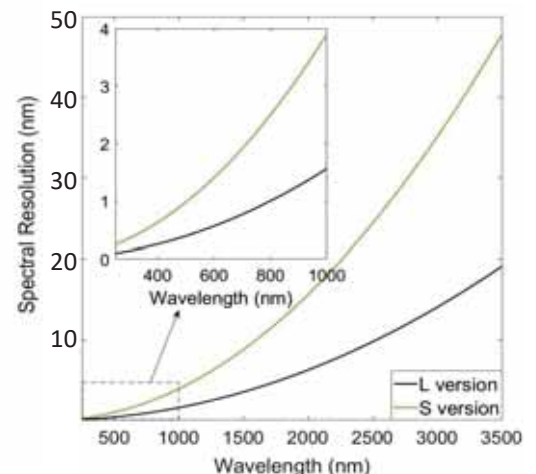

Specifications can be subject to change without notice.

For more information, please contact us via e-mail at [info@nireos.com](mailto:info@nireos.com) or visit our website [www.nireos.com](http://www.nireos.com)